

# Instruction Manual for L7

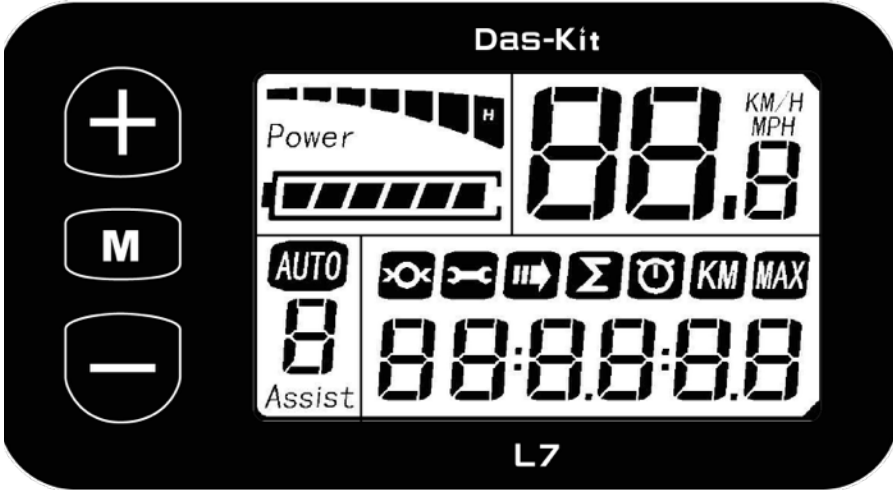

# 1. Instruction manual

Dear customer, please read the instruction manual carefully before operating your e-bike better. We'll show you every part of display instruction in the most concise language, including the installing, setting and normal use. At the same time, we'll help you solve problems.

## 2. Appearance and measurement

### 2.1 Main material and colour

The display adopts black ABS material and the support is made of nylon. The material of the shell can use normally among the temperature  $-20^{\circ}\text{C}$  to  $60^{\circ}\text{C}$  and guarantee good mechanical capacity.

Dimension figure (unit: mm)

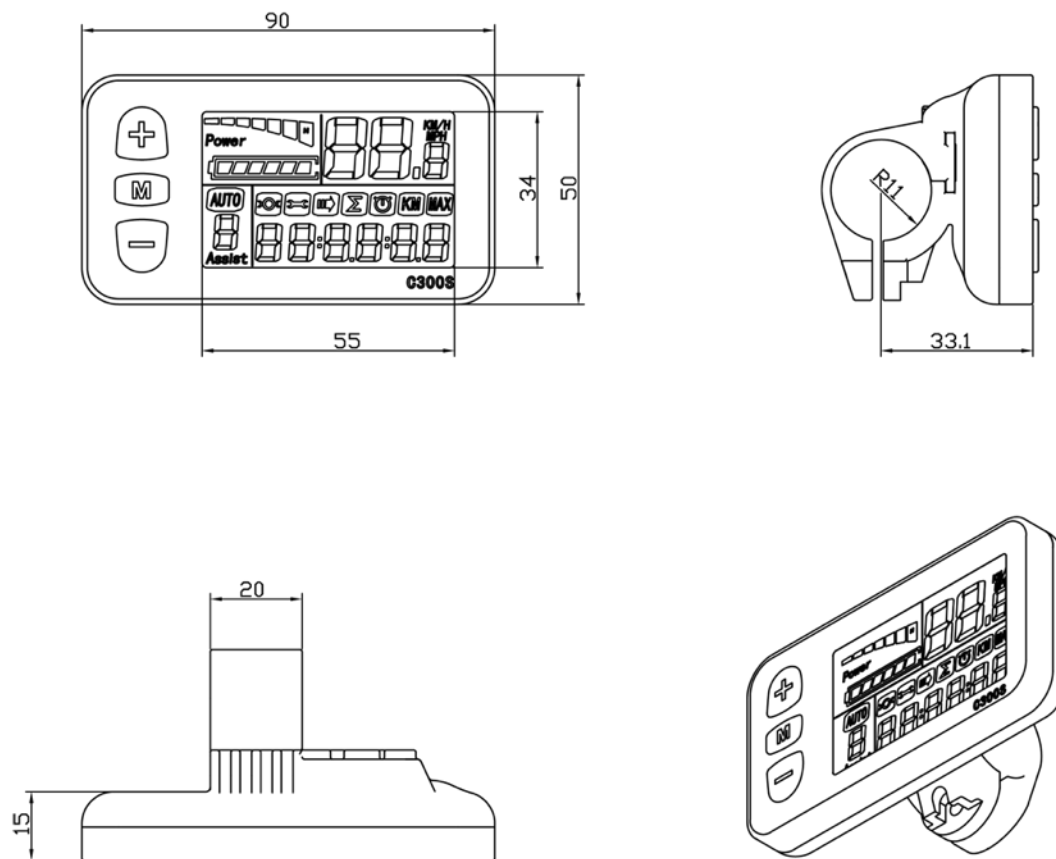

### 3. The button

There are three buttons on the display, including “M”, “+” and “-”.

“M” presents MODE/ON/OFF.

“+” presents UP. “-” presents DOWN.

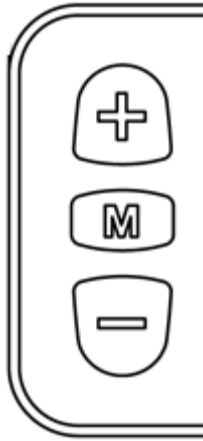

# 4. Function Display

## 4.1 FUNCTION SUMMARY

The indicated contents are as below.

1. Switch

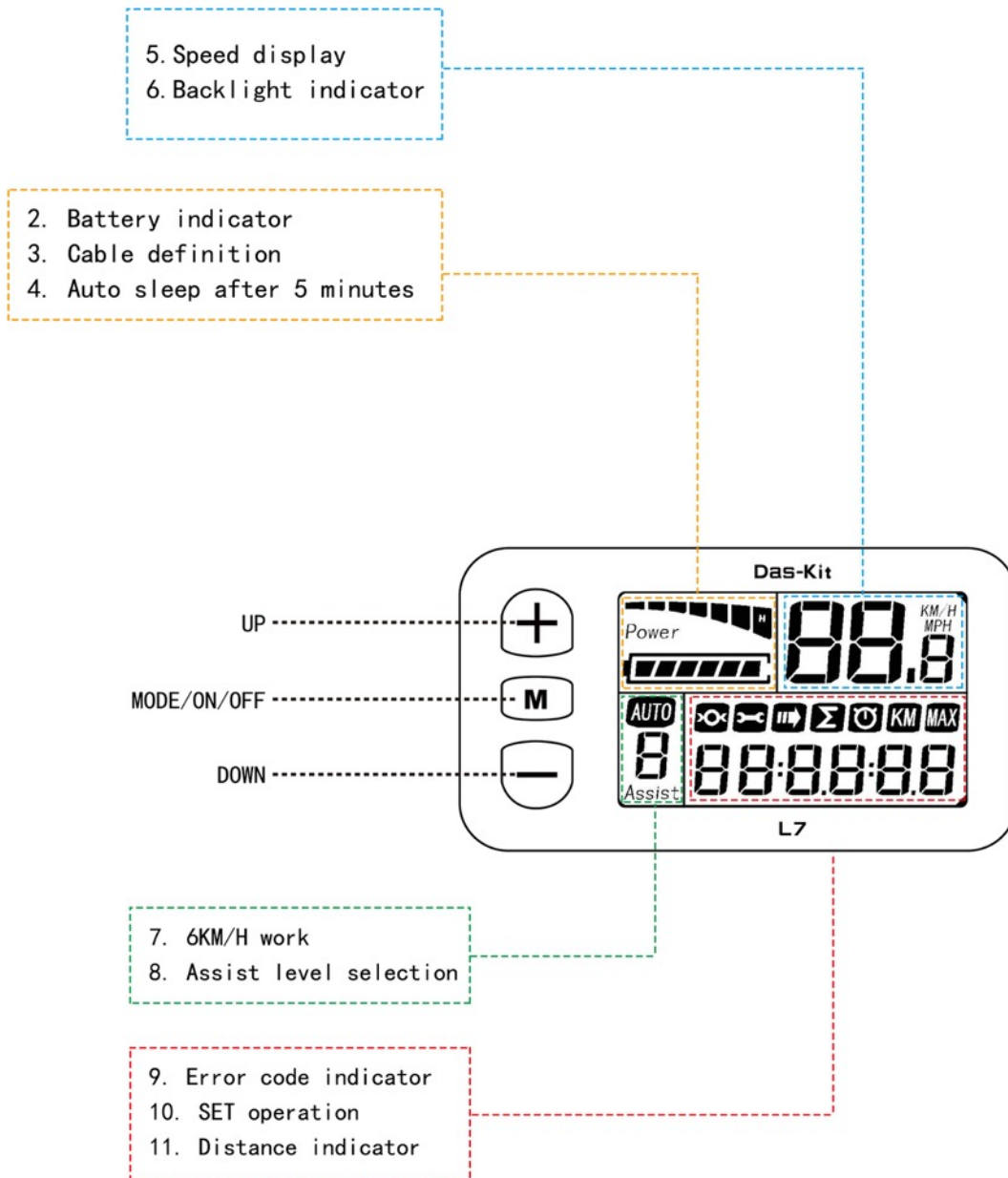

## 4.2 FULL VIEW AREA

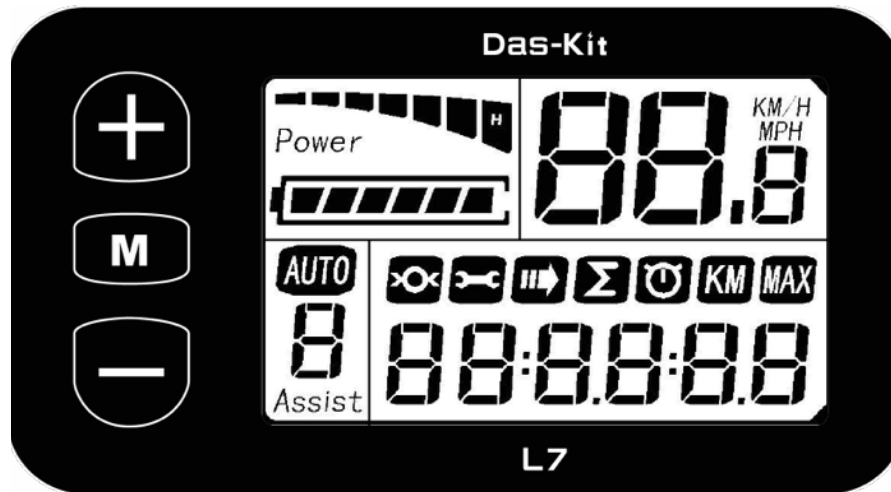

## 4.3 NORMAL VIEW AREA

The normal view area of the L7 is shown below.

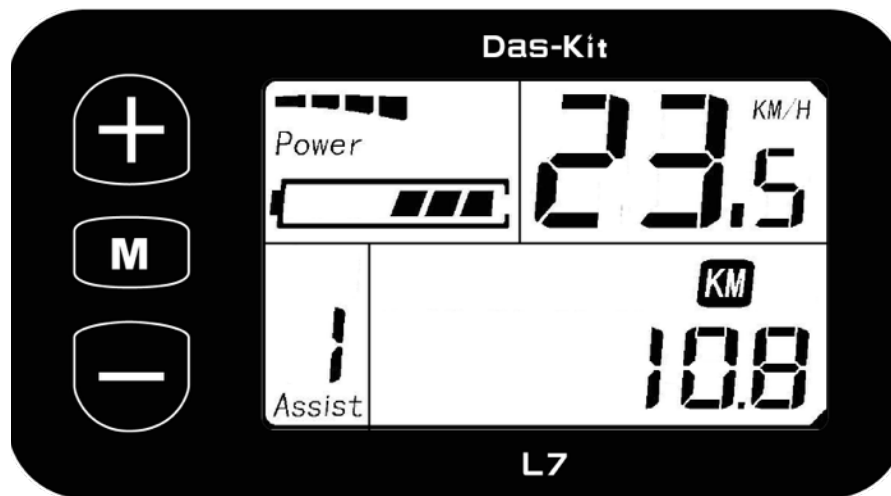

# 5. Normal operation

## 5.1 ON/OFF

Press M then the display is activated. With display on, press M for 2 seconds to turn off power. With the display off, there is no battery power consumption. The leakage current is no more than 2 $\mu$ A.

※The panel will automatically power-off when speed is 0 km/h for 5 minutes.

## 5.2 CURRENT DISPLAY

It represents the discharging current of the controller currently, each segment is 2A, six segments are  $\geq 12A$ .



## 5.3 SPEED DISPLAY

It displays the current riding speed of e-bike. The speed display is as below.



## 5.4 BACKLIGHT INDICATOR

With the power on, press "+" for 1 second can turn on the backlight. Press it for 1 second again can turn off the backlight.

## 5.5 6 KM/H WORK

Hold "-" for 2 seconds and enter into the mode of power assist walk. When the icon is lighting, the e-bike is traveling at 6km/h. Assist walk will be removed automatically after hand away. The assist walk display is as below.

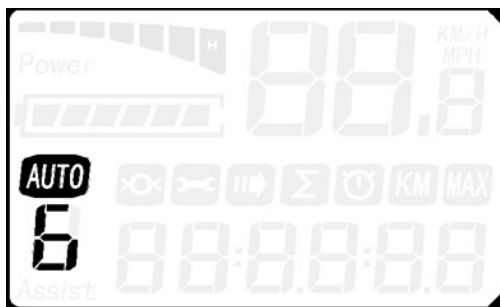

## 5.6 ASSIST LEVEL SELECTION

Click UP or DOWN to change the stages and output power ratio, the output power cycle from level 0 to level 6 for the default (the levels can be customized by user) , the default value is level 1.

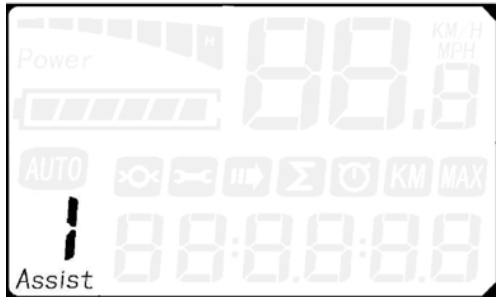

## 5.7 ERROR CODE DISPLAY

When the display comes up error, the icon and error code will flash together with 1Hz. Each error code is corresponding with the fault definition.

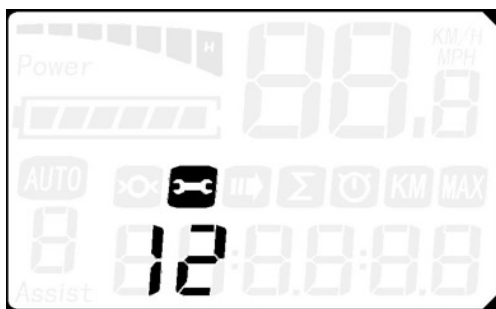

※ Only get rid of the error will clear the error code display.

The error code display is as below.

Error Code	Definition
0	normal
1	Current error or MOS damaged
2	Throttle error(detection after turning on)
3	motor without phase position
4	Hall error
5	Brake error(detection after turning on)
6	Under voltage
7	Motor stalling
8	communication controller receiving error
9	communication display receiving error

## 5.8 DISTANCE INDICATOR

With the display on, press M to switch the display information. In turn shows ODO, trip distance, riding time and max speed.



### 5.8.1 ODO

The ODO records the driving mileage from using.



### 5.8.2 Trip distance

Trip distance records the driving mileage. it displays as below. Hold “+” for 5 seconds, the trip distance will be reset and skip to the trip distance interface.

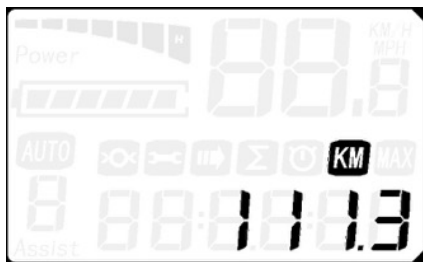

### 5.8.3 Trip time indicator

The trip time records the riding time, it displays as below.



### 5.8.4 Max speed



The max speed records the riding speed, it displays as below.

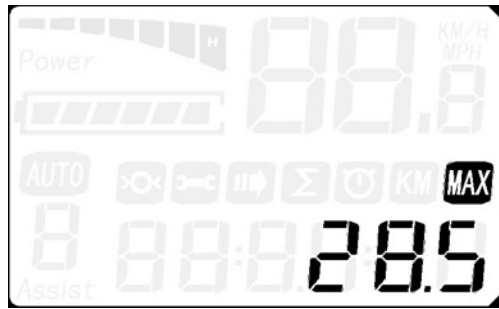

※Click  to start in turn show automatically.

### 5.11 BATTERY INDICATOR

When the battery capacity is high, the six battery segments are all light. When the battery is low, the battery frame will flash. It indicates that the battery is severely low and needs to be recharged immediately.

